



KE

ENJOY THE OUTDOORS

GENNIUS

KE THE RIGHT CHOICE

FOUR IMPORTANT REASONS TO CHOOSE KE

KE
ENJOY THE OUTDOORS

BAT GROUP:

Thanks to KE's experience and strong organization, we are a leading company in the field of retractable awnings and stationary products. KE is part of the BAT GROUP, a multinational company which guarantees positive synergies between materials, innovation and choices. KE is always investing in research in order to reach new solutions to improve functionality and elegance.

DESIGN:

The aim of KE designs is to achieve the optimal integration between the architecture and protection needs. Our design department is constantly involved in innovative research to add value and preserve the quality of the outdoor environment.

KE PATENTS:

KE offers innovative, operational and patented techniques. All the KE shading systems come from creative ideas which offer unique advantages in application and durability.

LONG-TERM INVESTMENT:

KE uses only the finest materials available from around the world to produce truly superior additions to your customers' home. Our advanced manufacturing and skilled craftsmanship technologies ensure KE customers will receive the highest quality products possible.

EXPAND YOUR OUTDOORS...

LIVE THE OUTDOORS!

KE Durasol's Gennius is a unique concept in retractable awning systems. The Gennius can protect you from the wind and rain, block harmful UV rays and keep you cool and comfortable in the brightest sunshine. The Gennius combines the beauty of a pergola, the flexibility of a retractable awning, and the warmth and comfort of a room addition.

The Gennius can cover a small deck, a large patio, or an expansive pavilion. The optional hood for the Gennius keeps debris from collecting in the fabric when it is retracted, which is available on all models. The blackout fabric blocks 100% of damaging and uncomfortable UV light and heat, keeps the rainwater off your head, and prevents the shadow lines that appear below from environmental pollution that can settle on the top side. Create a "retractable room" with optional "zip" drop curtains in the front and on the sides underneath a fixed fabric gable wing. The curtains can operate manually with a gear or be motorized. Put sun-screen mesh in the drop curtains, or use vinyl fabric with crystal-clear windows. Also available with sliding glass screens.



A2C

EXPAND YOUR OUTDOOR LIVING SEASON...

GENNIUS PROVIDE RESISTANCE TO THE ELEMENTS, DURABILITY, AND FUNCTIONALITY USING UP TO DATE TECHNOLOGY. THE BEST DEFENSE OF ANY INVESTMENT IS QUALITY, DESIGN, FUNCTIONALITY, DURABILITY, AND PERFORMANCE

- Wedding and banquet halls can guarantee dry functions
- Restaurants can create or expand outdoor seating
- Improve the ambiance with optional integrated LED lighting and Audio
- Generate revenue even in inclement weather
- Fully protect your space with optional perimeter solar shades (not all models)
- Improve dining and entertainment space for Country Clubs and more...
- Glass screens





L15

GENNIUS

FEATURES & BENEFITS



Maximum width dimensions on a single unit up to 42' 8", projection up to 26' and beyond



You control the amount of sun you want to let in



Installation manual guarantees easy install due to explicit instructions



Rainproof retractable fabric



Wind resistance: all products receive rigorous environmental testing — industry standard classification - EN13561:2015



Installation is adaptable to wall and freestanding units, also serves as a roof for existing frameworks



Complete rain water management with the patented guiderail gaskets, optional gutter, and downspouts



GENNIUS A2C



A2C

The Genius A2C has the elegant look of a pergola. The fabric guiderail system is supported by a strong and durable integrated extruded aluminum structural rafter and column. The header and column frame-work feature the aesthetic appeal of a traditional pergola

Width dimensions in a single unit up to 42' 8".

Projection dimensions up to 26' 3".

The Genius A2C has the elegant look of a pergola. The fabric guiderail system is supported by a strong and durable integrated extruded aluminum structural rafter and post. The header and column framework feature the aesthetic appeal of a traditional pergola.

The fabric in the roof is a 3 ply construction – the exterior layers on the top and bottom look beautiful.

The blackout layer in the center blocks 100% of damaging and uncomfortable UV light and heat, keeps the rainwater off your head, and prevents the shadow lines that appear below from environmental pollution that settles on the top side.

Complete rain water management with the patented guiderail gaskets, integrated gutter, and integrated downspouts.

Width dimensions in a single unit up to 42'8".

Projection dimensions up to 26'3".

Slope is essential to manage and remove rainwater. Water is very heavy. If any Genius is installed without the minimum recommended slope, rainwater runoff management will be compromised. Genius units that are installed without the minimum recommended slope cannot be considered a rain cover. The consumer should be informed of and understand this fact.

Units up to 23' wide get single piece fabric profile unless specified.

Motorized operation with remote control.

Optional hood protects motor assembly and keeps debris from collecting in the fabric when your Genius is retracted.

Create a "retractable room" with optional integrated "zip" drop curtains, in the front, and on the sides underneath a fixed fabric gable wing. The curtains can operate manually with a gear, or be motorized. Put sun-screen mesh in the drop curtains, or, use vinyl fabric with crystal-clear vinyl windows.

Glass Screens also available.



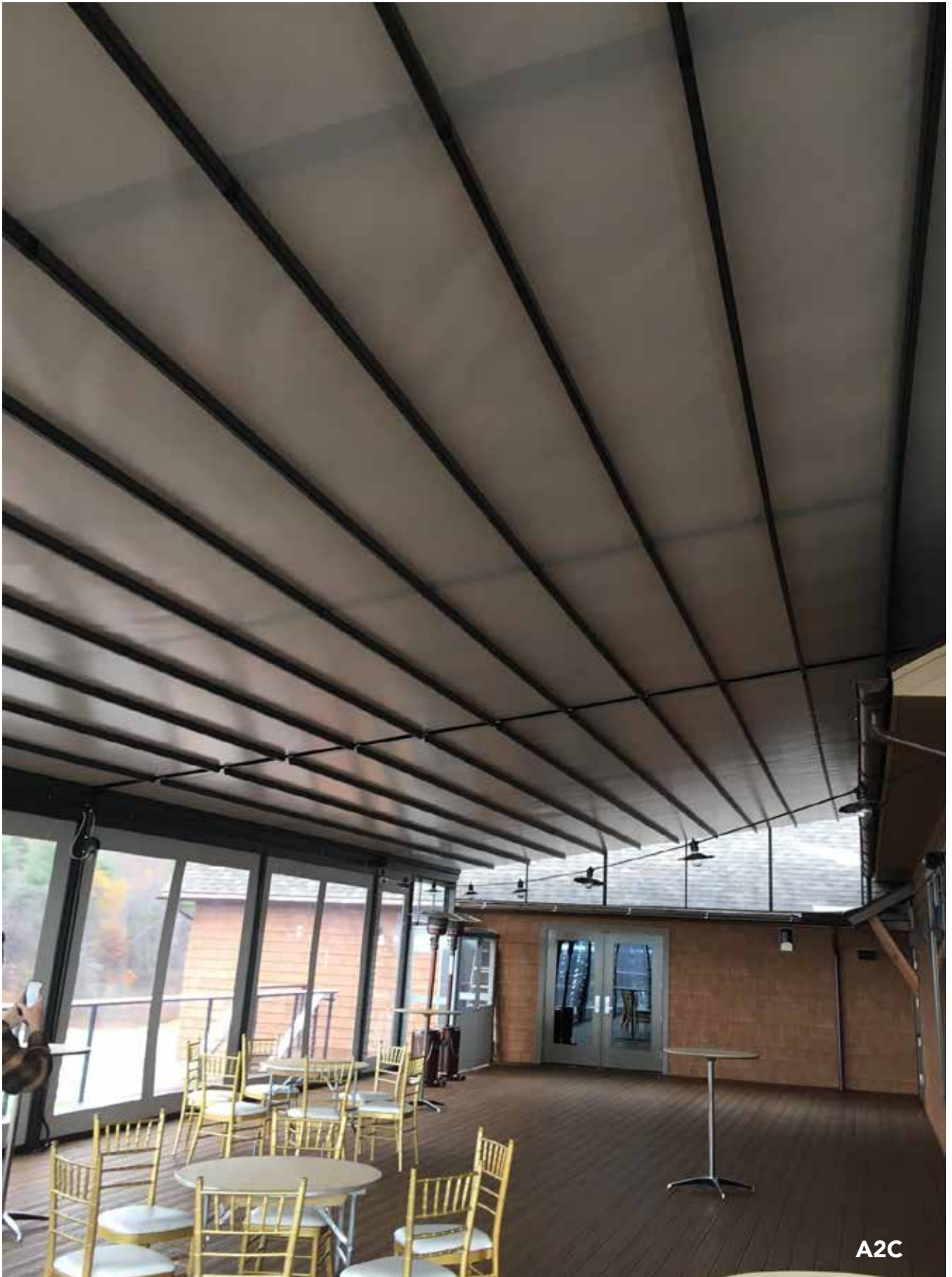

A2C



A2C



GENNIUS A100



The basic Gennius, the A100, is a unique rainproof retractable fabric roof system, with an integrated extruded aluminum structural support and fabric guiderail system.

The fabric in the roof is a 3 ply construction – the exterior layers on the top and bottom look beautiful.

The blackout layer in the center blocks 100% of damaging and uncomfortable UV light and heat, keeps the rainwater off your head, and prevents the shadow lines that appear below from environmental pollution that settles on the top side.

Complete rain water management with the patented guiderail gaskets, optional gutter, and integrated downspouts.

Width dimensions in a single unit up to 42'8".



Projection dimensions up to 18'.

Motorized operation with remote control.

Optional hood protects motor assembly and keeps debris from collecting in the fabric when your Genius is retracted.

Create a "retractable room" with optional integrated "zip" drop curtains, in the front, and on the sides underneath a fixed fabric gable wing. The curtains can operate manually with a gear, or be motorized. Put sun-screen mesh in the drop curtains, or, use vinyl fabric with crystal-clear vinyl windows.

Glass Screens also available.





A100



A100



A100

GENNIUS ISOLA 2





The Isola 2 is a self-supporting, or freestanding unit. The structure differs from the classic product Gennius for the roof structure, having the guides perfectly positioned horizontally and laterally tilting the sheet to allow the flow of water in gutters around the perimeter. The columns are perfectly square, the eaves and roof system make the Isola 2 extremely compact and aesthetic. With its innovative design, shaped as a cube, the inclination of the cover make it distinct and unique.

The Isola 2 protects you or your guests from wind and rain, it also blocks harmful UV rays, keeping you cool and comfortable in the brightest sunshine. With projections starting at 8' 2" up to 29' 6" for single module, provides cover to any part of your outdoor living area.

Blackout fabric, is available in white, sand, ivory, and blocks 100% of damaging and uncomfortable UV light and heat. This blackout fabric prevents shadow lines that appear below from environmental pollution that can settle on the top side.

Wind resistance guaranteed up to class 6 according to UNI EN PR 13561 standards. Isola 2 is not made to withstand the weight of snow.

Accessorize your Isola 2 with: lights, optional zip solar shades, glass screens, and the Somfy® sun, wind, or rain sensor.

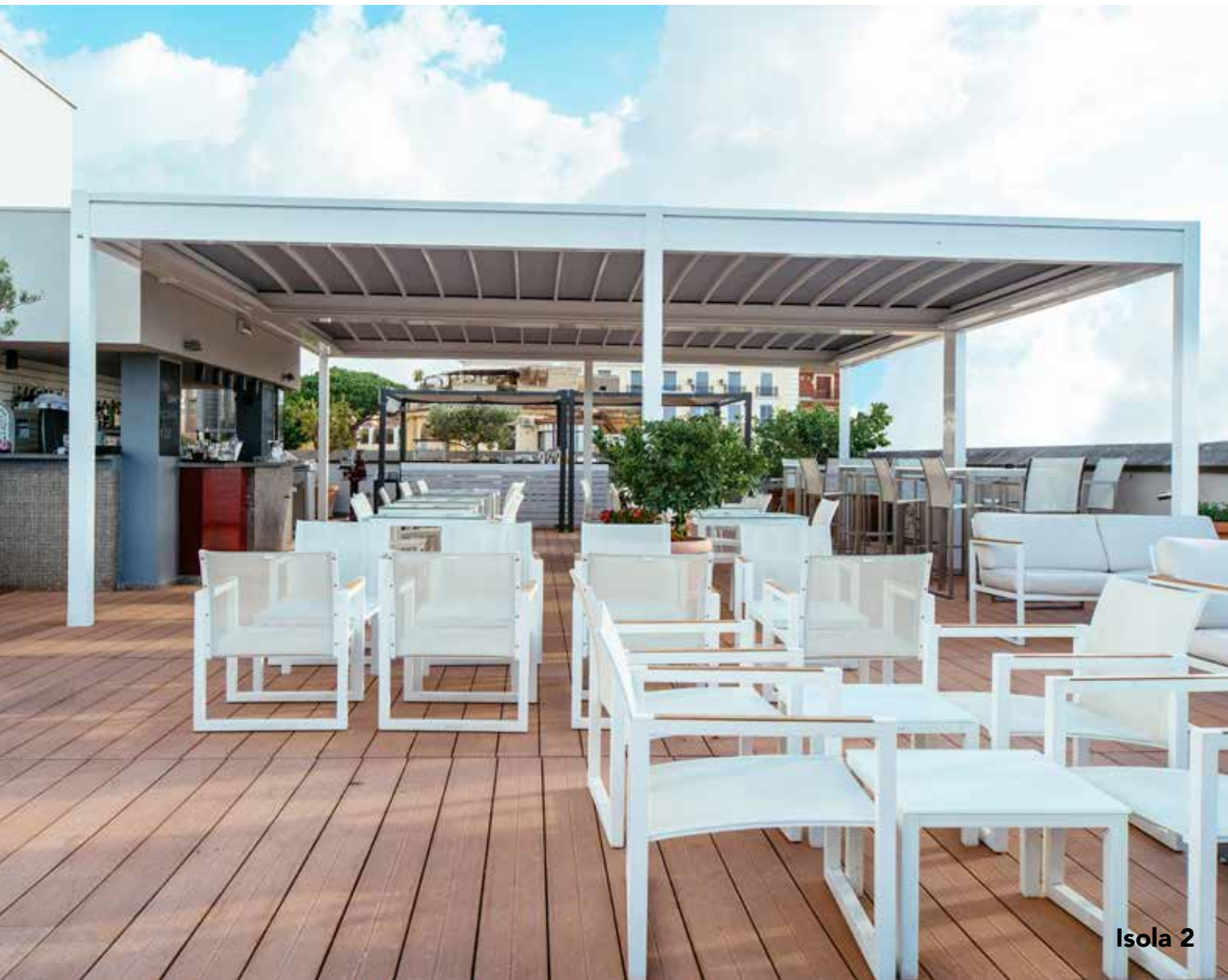

Isola 2



Isola 2

Isola 2 perfect patio covers for:

- Golf Courses
- Country Clubs
- Private Dining —
Improve dining and entertainment spaces
- Optional dimmable LED lights
- Projects up to 29' 6"

Perfect for any type of celebration!



EXPAND YOUR OUTDOOR DINING



Isola 2



GENNIUS L1S

@pure barre

SALON PURE



Create a “retractable room” with optional integrated “zip” drop curtains, in the front, and on the sides underneath a fixed fabric gable wing. The curtains can operate manually with a gear, or be motorized. Put sun-screen mesh in the drop curtains, or, use vinyl fabric with crystal-clear vinyl windows. The Gennius L1S has the traditional appearance of a wooden pergola.

The Fabric guiderail system is supported by engineered laminated layer wood rafters, header, and columns. Strong and durable, but with the traditional warmth and appeal of wood.

Complete rain water management with the patented guiderail gaskets, and downspouts.

Width dimensions in a single unit up to 42’ 8” and projections dimensions up to 19’ 8”.

The fabric guiderail system is supported by engineered laminated layer wood rafters, header, and columns. Strong and durable, but with the traditional warmth and appeal of wood.

The fabric in the roof is a 3 ply construction – the exterior layers on the top and bottom look beautiful.

The blackout layer in the center blocks 100% of damaging and uncomfortable UV light and heat, keeps the rainwater off your head, and prevents the shadow lines that appear below from environmental pollution that settles on the top side.

Slope is essential to manage and remove rainwater. Water is very heavy. If any Gennius is installed without the minimum recommended slope, rainwater runoff management will be compromised. Gennius units that are installed without the minimum recommended slope cannot be considered a rain cover. The consumer should be informed of and understand this fact.

Units up to 23’ wide get single piece fabric profile unless specified.

Motorized operation with remote control.

Optional hood protects motor assembly and keeps debris from collecting in the fabric when your Gennius is retracted.

Create a “retractable room” with optional integrated “zip” drop curtains, in the front, and on the sides underneath a fixed fabric gable wing. The curtains can operate manually with a gear, or be motorized. Put sun-screen mesh in the drop curtains, or, use vinyl fabric with crystal-clear vinyl windows.

Gennius L1S contains wood components that requires mandatory maintenance to insure warranty.

Glass Screens



L1S



GENNIUS KEDRY



KEDRY



Waterproof structure.

Automation capabilities of the louver blades through wind, snow, rain sensors. Maximum width dimensions on a single unit up to 13', projection up to 26'.

The first roof with waterproof louver blades, aluminum framework with swiveling louver blades, designed to ensure optimal resistance against the elements. Moved by sturdy and powerful linear motors and designed to fit any kind of patio, terrace, or outdoor space.

The KEDRY can be closed all around through either side with awnings, zippers, or windows.



KEDRY



KEDRY



KEDRY

T1





The Gennius T1 retro-fits onto an existing pergola. Your pergola looks beautiful; now make it equally functional with the addition of the shade and rain water protection that the Gennius system offers.

This unit is an aluminum guiderail system from our Gennius A1, which is supported by the existing structure. The fabric in the roof is a 3 ply construction – the exterior layers on the top and bottom look amazing.

The blackout layer in the center blocks 100% of damaging and uncomfortable UV light and heat, keeps the rainwater off your head, and prevents the shadow lines that appear below from environmental pollution that settles on the top side.

Complete rain water management with the patented guiderail gaskets, optional gutter and downspouts. Just add sufficient pitch, and rainwater will roll off the front of the Gennius.

Width dimensions in a single unit up to 42'8" and projection dimensions up to 29'6" (when supported by an existing structure).



T1 on a Pergola -retracted



T1 on a Pergola - fully retracted



Combine charm and elegance
with every lifestyle...

Pure Genius

T4



T1



The Gennius T4 is a cantilever option of T1.

Projection does not include pitch

Waterproof. Mounted to wall.

No posts

The fabric in the roof is a 3 ply construction – the exterior layers on the top and bottom look beautiful.

The blackout layer in the center blocks 100% of damaging and uncomfortable UV light and heat, keeps the rainwater off your head, and prevents the shadow lines that appear below from environmental pollution that settles on the top side.

Complete rain water management with the patented guiderail gaskets, and optional gutter. Just add sufficient pitch, and rainwater will roll off the front of the Gennius.

Width dimensions in a single unit up to 42'8".

Projection dimensions up to 13'1".

Slope is essential to manage and remove rainwater. Water is very heavy. If any Gennius is installed without the minimum recommended slope, rainwater runoff management will be compromised. Gennius units that are installed without the minimum recommended slope cannot be considered a rain cover. The consumer should be informed of and understand this fact.

Units up to 23' wide get single piece fabric profile unless specified.



LIGHTS AND MUSIC OPTIONS

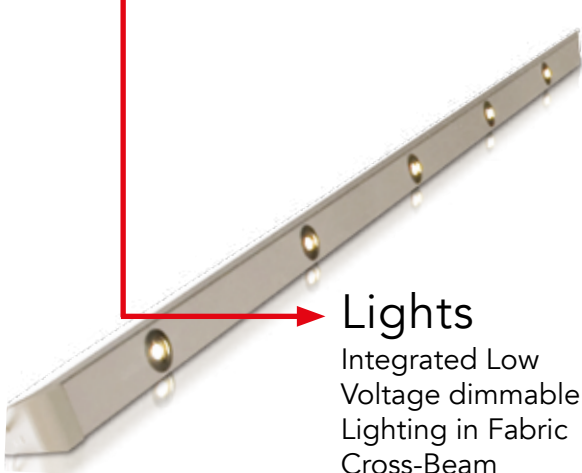

Lights
Integrated Low Voltage dimmable Lighting in Fabric Cross-Beam Profiles. Available with dimmable lights



Music
Integrated Speakers in Fabric Cross-Beam Profiles

HOOD/ GASKET

The Genius hood is produced with a special aluminium panel, particularly robust, light, rain drop quiet, and unobtrusive. The hood panel will be white, top and bottom. The surrounding framing will be frame color matched to the guiderail color.

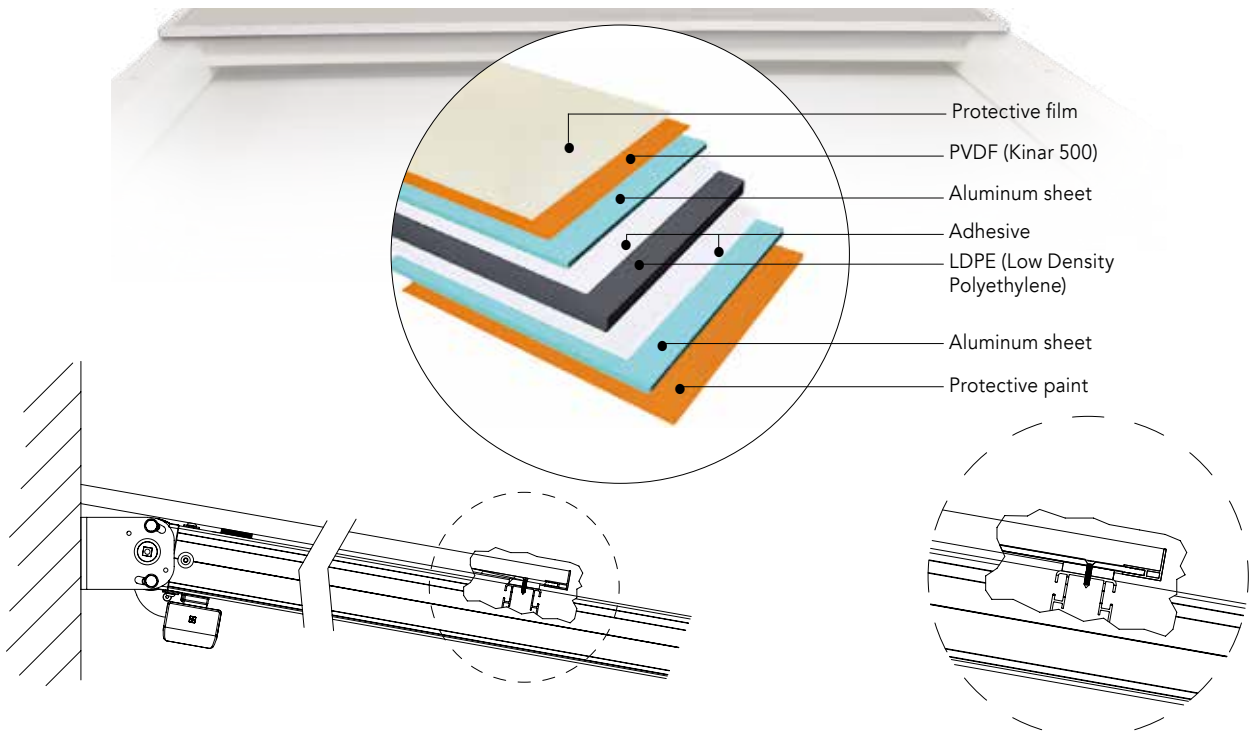

Gasket

The double fin gasket is produced by Co-extrusion technology between two materials with different characteristics: PVC and plastified polyurethane.

The former gives:

- Stiffness on the guide hooking part and makes the gasket fixed.
- The latter gives elasticity to the parts which are in contact with the fabric to avoid the PVC memory effect.
- This patented double fin structure assures rain water is routed into the gutter and does not spill over the sides, even in windy conditions.



ENGINEERING CERTIFICATION



WIND RESISTANCE - CLASS 3

The Genius design principle is to achieve both aesthetic beauty and durable, reliable function. All of Genius' components are designed and manufactured to satisfy these goals. Genius is tested and approved to comply with standard EN 13561, Class 3: the most stringent standard.

In fact, the actual test results indicate that Genius' performance is superior to the standards specified in EN 13561.



All Genius models have the CE Certification, an assurance of quality.

See Care & Maintenance Packet

Maintenance & Care Package has to be followed otherwise warranty is voided.

SWAG FABRIC/ FRAME COLORS

To add elegance to your Gennius, apply the Swag fabric draping to the bottom of the crossbeam profiles. The Swag fabric is easy to install and does not create further bulk.



FRAME COLORS

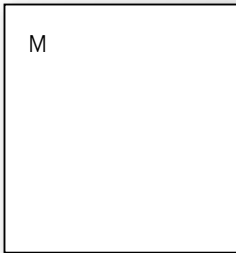

WHITE

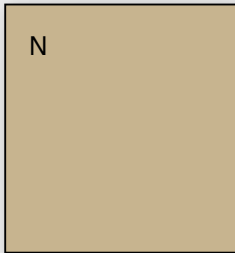

SAND

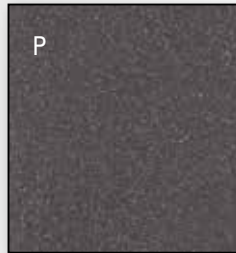

CHARCOAL

FRAME COLORS FOR L1S

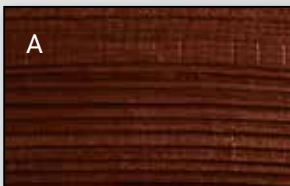

IMPREGNATED DARK WALNUT
MADERA IMPREGNADA CAOBA



IMPR. SEMI-GLOSSY MAHOGANY WOOD
MADERA IMP. CAOBA SEMILÚCIDO

Custom colors available

SOMFY® MYLINK™



SOMFY Mylink
WIFI Interface



Easily transform your experience with Somfy- powered motorized solutions and maximize the benefits that they provide, such as energy savings, privacy, comfort and convenience. The myLink puts you in control, so that you can operate your motorized shades, blinds, awnings, screens and shutters with your favorite mobile device whether you're home or not.

ONDEIS™ WIREFREE

Ondeis™ WireFree RTS Rain and Sun Sensor



Perfect for the Gennius the Rain Sensor is a solar-powered combined rain and sun sensor compatible with Radio Technology Somfy® motorized exterior products, including awnings, rolling shutters and screens. The Sensor is completely wireless and uses optical rain-sensing technology to measure rainfall and sends an RTS command when rainfall exceeds the user-selected threshold. The Sensor also utilizes a sun-level sensor that sends an RTS command when sunlight exceeds the user-selected threshold.

FERRARI PRECONSTRAINT 502 & 602

Preconstraint 502 is an architectural PVC textile by SERGE FERRARI. Designed and developed for applications such as; facade blinds, shade sails, canopies and light structures, 502 is made using SERGE FERRARI's Preconstraint technology

The 40 colors in the Preconstraint 502 range have been specially created with industrial and architectural applications in mind. The adaption to current and future trends and the addition of metallic finishes and interferential colors bestow enduring individual traits to every project. Preconstraint 502 is a 100% recyclable textile and membranes are pressed overtime.



Preconstraint 602: **Blackout fabric** available in White, Ivory, and Sand.

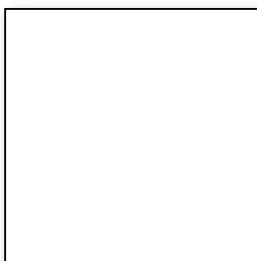

WHITE

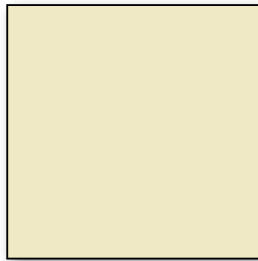

IVORY

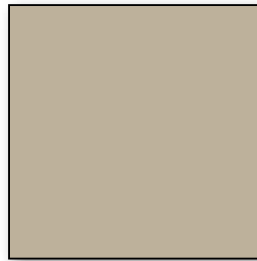

SAND

KE

ENJOY THE OUTDOORS

Corporate Headquarters USA
445 Bellvale Road
Chester, NY 10918
888-387-2765
845-610-1100

California Division
1510 S. Auto Center Drive
Ontario, CA 91761
844-387-2765

Commercial Division
38 Pond Lane, Suite B
Middlebury, VT 05753
802-388-7309

www.keoutdoordesign.us